



EXTRA LOW VOLTAGE BOOT CLEANER



WWW.PROLECAUSTRALIA.COM.AU

P: 02 49649660 E: sales@prolecaustralia.com.au



EXTRA LOW VOLTAGE BOOT CLEANER

The BootPro ELV is a world-first revolutionary low-voltage motorised industrial strength boot cleaner. Specifically designed & manufactured for the mining industry with a focus on performance and durability to enhance machine operator safety. By removing the dirt & mud from footwear before entering the machine operator cab it minimises the dust particles created when the mud dries out, keeping the cab cleaner & safer for operators. Designed to combat harmful airborne contaminants, it's the perfect solution for areas where dirt, mud and grit accumulate, ensuring cleaner boots and a safer working environment.

Mud and debris on work boots can dry, becoming dust that not only dirties your workspace but also poses a risk of respirable particulates. The BootPro ELV is the perfect tool to support existing safety systems to meet ISO 23875 requirements for cab air quality, effectively removes stubborn mud and helps protect your workforce from exposure to hazardous particles by removing the mud & dirt before the operator enters the cabin.

Constructed from marine-grade 316 stainless steel, the BootPro ELV features three heavy-duty brushes to clean both sides and the sole of your boots effortlessly. Easily mounted on industrial vehicles, the BootPro ELV offers seamless installation and superior boot-cleaning performance, making it a must-have for any worksite.

WORLD-FIRST EXTRA LOW VOLTAGE DESIGN

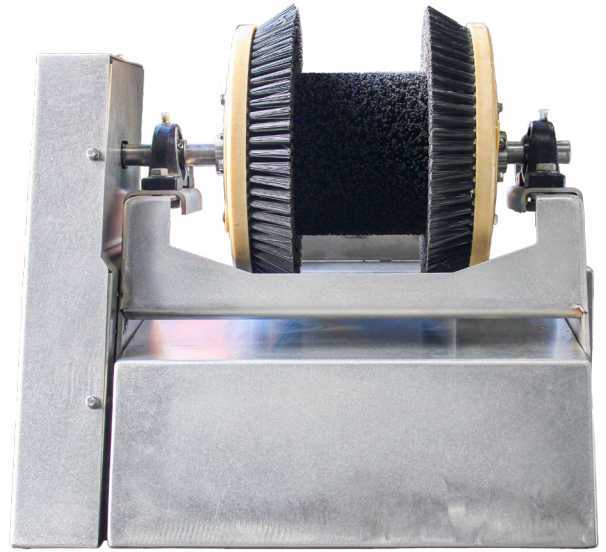

PATENT PENDING
Int. Patent App. PCT/AU2024/05095
Registered Design 202315886

CLICK BOOTS TO SEE HOW IT WORKS



KEY FEATURES



Durable Modular Mounting Bracket

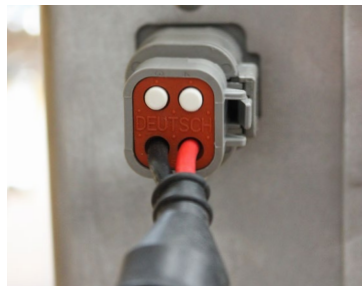

24V Deutsch Connector

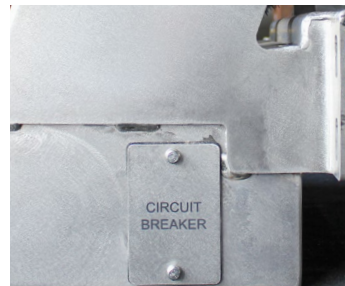

In-built Circuit Protection



Pre-wired for Fast Installation



MANUFACTURED BY



EXTRA LOW VOLTAGE **BOOT CLEANER**

SUGGESTED MINING MACHINERY

HAUL TRUCK



DRILL RIG



EXCAVATOR



FRONT END LOADER



GRADER



BULLDOZER



PRODUCT CODES

BOOTPRO-2-ELV

24VDC BootPro Raw Stainless Steel Finish

BOOTPRO-2-ELV-BLK

24VDC BootPro Powdercoated Black Finish

BOOTPRO-2-ELV-CAT

24VDC BootPro Powdercoated CAT Yellow Finish

BOOTPRO-2-ELV-HIT

24VDC BootPro Powdercoated Hitachi Grey Finish

BOOTPRO-2-ELV-KOM

24VDC BootPro Powdercoated Komatsu Yellow Finish

BOOTPRO-2-ELV-LIE

24VDC BootPro Powdercoated Liebherr White Finish



MANUFACTURED BY



EXTRA LOW VOLTAGE **BOOT CLEANER**

SPECIFICATIONS

VOLTS - 24 VDC
CURRENT - 10 A
SPEED - 600 RPM
WEIGHT - 47 KG

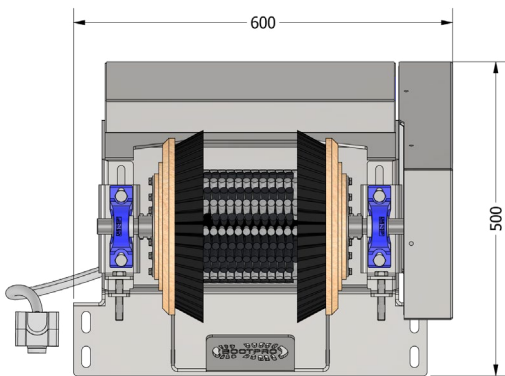

TOP VIEW

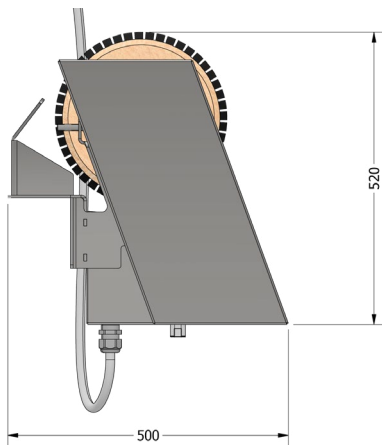

SIDE VIEW

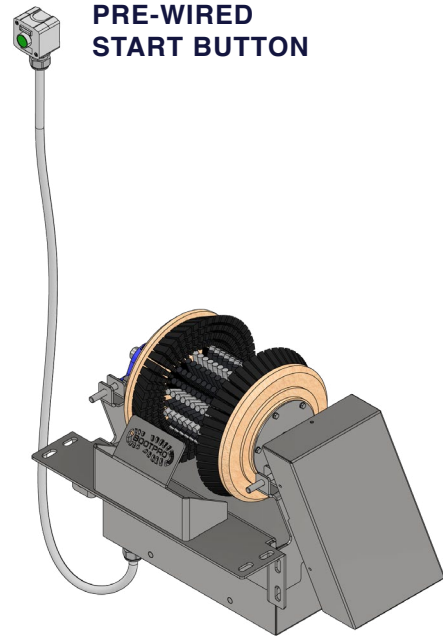

**PRE-WIRED
START BUTTON**

ISOMETRIC VIEW

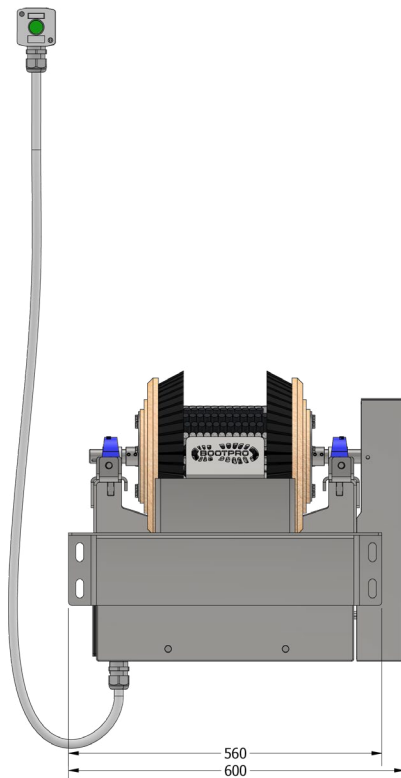

FRONT VIEW